



# INSTRUCTION MANUAL

# NOMAD® NOW HORIZONTAL

# RIGHT ANGLE MOUNT

---

P/N 85-046

Please read below before using your Nomad NOW Horizontal Right Angle Mount as it relays beneficial operating and safety information.

## PHYSICAL CHARACTERISTICS

- Anodized aluminum
- 8 x 2 in (203 x 51 mm) bracket
- 8 oz (227 g)

## INSTALLATION OF HORIZONTAL RIGHT ANGLE MOUNT

1. Secure your Nomad® NOW to the Horizontal Right Angle Mount with provided hardware.
2. Tighten the mount (including the installed Nomad® NOW) to the 1/4 -20 threaded stud of your tripod.
3. Additional through-hole locations are provided for hanging and securing of extra items.

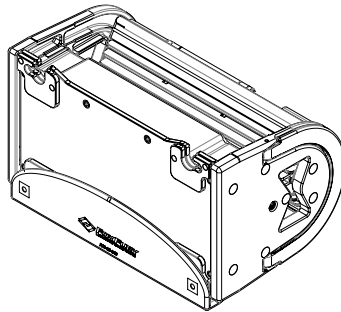
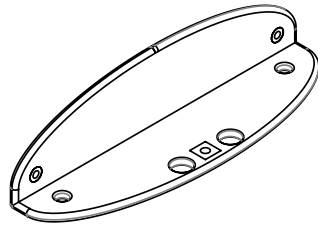







# WARRANTY AND OTHER INFORMATION

---

## WARNINGS

FoxFury, LLC is not responsible for the incorrect use of any FoxFury Lighting product.

-  When used for extended periods of time the Nomad® will become HOT to the touch. Please use care when operating.
-  Do not stare into LEDs for long periods of time or from a close range (less than 2 ft).
-  FoxFury, LLC is not responsible for any injury or damage caused during the use of this product.
-  Usage of this product must be supervised by an adult when it is being used by a minor.
-  Any FoxFury product should be operated at speeds safe enough to maneuver around surrounding obstacles.
-  Do not use under the influence of drugs or alcohol.

## LIMITED LIFETIME WARRANTY

FoxFury, LLC ("FoxFury") warrants this product to be free from defects in material for a lifetime of use except for batteries, LEDs, abuse, and normal wear. We will repair or replace this product should we determine it to be defective. This limited lifetime warranty excludes rechargeable batteries, chargers, switches, and electronics, which have a 2-year warranty with proof of purchase.

This limited lifetime warranty is given only to the original end user of the accompanying product. If you purchased a product from someone other than an authorized FoxFury reseller/distributor or if the product was used, (including but not limited to demo models, show models or refurbished product by someone other than FoxFury) prior to your purchase, you are not the Original Purchaser and the product that you purchased is not covered by this warranty. This limited warranty is VOID if this Product has been altered or modified in any way (including but not limited to attempted warranty repair without authorization from Foxfury and/ or alteration/removal of the serial number). To expedite warranty concerns, we encourage the end user to register their FoxFury Product at [www.foxfury.com/pages/warranty-registration](http://www.foxfury.com/pages/warranty-registration).

THIS IS THE ONLY WARRANTY, EXPRESSED OR IMPLIED, INCLUDING ANY WARRANTY OF MERCHANTABILITY OR FITNESS FOR A PARTICULAR PURPOSE. INCIDENTAL, CONSEQUENTIAL OR SPECIAL DAMAGES ARE EXPRESSLY DISCLAIMED EXCEPT WHERE SUCH LIMITATION IS PROHIBITED BY LAW.

You may have other specific legal rights which vary by jurisdiction. Go to [www.foxfury.com/pages/warranty](http://www.foxfury.com/pages/warranty) for a complete copy of the warranty. Retain your receipt for proof of purchase.

## CONTACT FOXFURY

FoxFury, LLC  
Oceanside, CA 92056 USA  
**Toll-Free:** 844-FOXFURY  
**Tel:** 760.945.4231  
**Fax:** 760.433.3650  
**Email:** [service@FoxFury.com](mailto:service@FoxFury.com)  
**Web:** [FoxFury.com](http://FoxFury.com)

All FoxFury products are designed in Oceanside, CA. All FoxFury products are manufactured with the highest quality USA and foreign parts. Products are assembled in either FoxFury's controlled plant in Asia or the USA, under strict quality control.